

44.900

Addit monitorverhoger 900

Deze multifunctionele monitorverhoger biedt ook ruimte aan een telefoon of een set bureaubladspeakers. Er is voldoende ruimte aan de onderzijde voor het opbergen van een toetsenbord en de maximale draagkracht is 30 kg.

- Geschikt voor monitors tot 30 kg
- Ruimtebesparende toetsenbordopslag onder de standaard
- 6 mm dik helder acryl
- Bespaart bureauruimte
- Vaste hoogte
- Afmetingen (b x d x h): 512 x 310 x 97 mm
- Ruimte voor monitor en telefoon of speakers

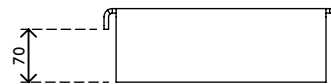
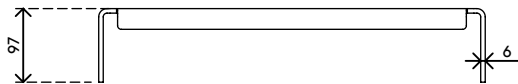
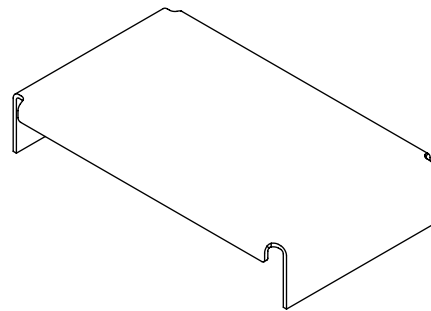
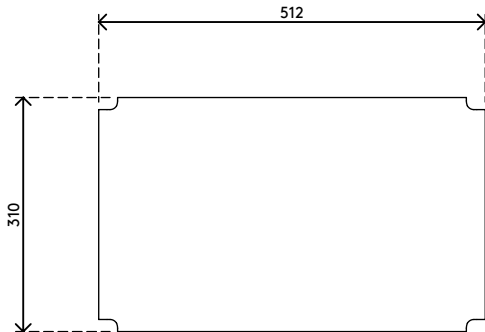

30 kg

Addit monitorverhoger 900

2020/05/26

44.900

 550 x 315 x 110 mm

 1 pcs

 helder acryl

 2,01 kg

 805410449001