

# viewmaster<sup>x</sup>

Garanzia



53.833

## Viewmaster sistema multi-monitor - scrivania 833

Concepito per i settori della sicurezza e finanziario, in cui le persone hanno bisogno di osservare simultaneamente molti flussi di dati. Questo sistema multi-monitor può supportare fino ad 8 monitor e posizionarli in maniera tale da creare una parete di display completamente piatta oppure una stazione di lavoro con monitor incurvata.

- Regolazione graduale dell'altezza
- Per 8 monitor
- Clip per cavi e fascette ferma cavi comprese
- Parti in alluminio pressofuso
- Compatibile con VESA MIS-D 75 x 75/100 x 100 mm
- Monitor: inclinazione +55°/-55°, orientabile +90°/-90°, rotazione 360°
- Capacità peso max. di 12 kg per monitor
- Fissaggi per scrivania non inclusi
- Dimensioni massime monitor: larghezza 500 mm - altezza 428 mm
- Grazie all'eccellente stabilità è adatto anche per i touchscreen

**dataflex**<sup>x</sup>

feeling at work

# viewmaster x

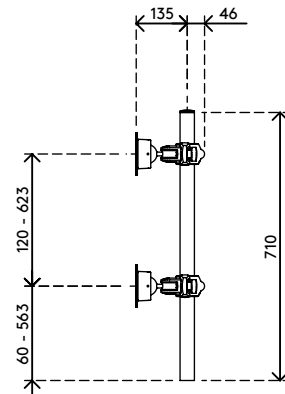
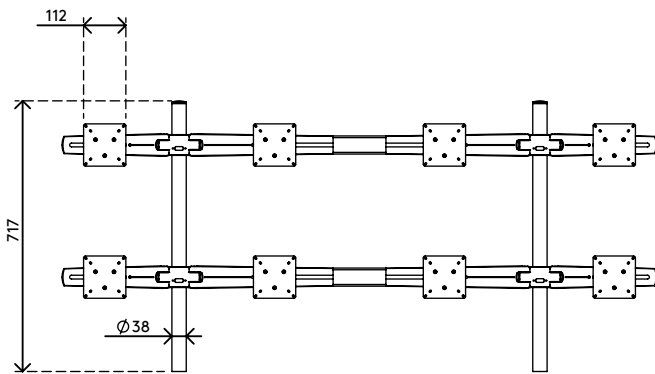
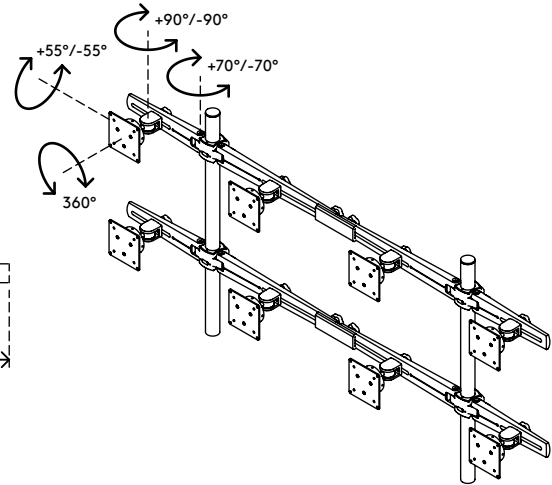
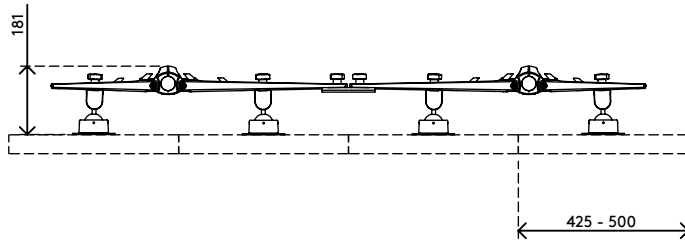

+55°/-55°

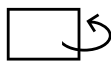

+90°/-90°



360°



500 mm (19,7")



428 mm (16,9")



75 x 75/100 x 100



(8x) 12 kg

Viewmaster sistema multi-monitor - scrivania 833

2020/10/07

# 53.833

 760 x 410 x 270 mm

 1 pcs

 nero

 19,68 kg

 805410538330