



Beyond chairs and desks

Complement your working environment
with ergonomic computer workplace accessories.

Feeling at work

At Dataflex, our mission is to empower individuals in their professional work life by designing and producing innovative, ergonomic computer workplace accessories that enhance comfort, productivity, and well-being. We are dedicated to delivering forward thinking solutions that adapt to the evolving needs of people in the modern workspace, whilst leaving the smallest possible footprint on our planet.

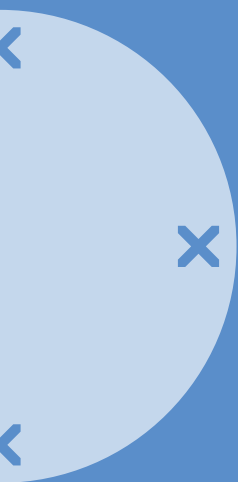

Vision Statement:

Driven by a commitment to excellence, Dataflex envisions a future where workspaces seamlessly blend functionality, comfort, and sustainability. By continuously exploring ergonomic design, we aspire to be a pioneer for workplace accessories, creating environments that inspire creativity, foster collaboration, and promote overall employee satisfaction. We want to be the global benchmark for how businesses in our field operate. With continuous integrity, accountability, and a profound respect for every encounter, our commitment is to leave a positive imprint on every aspect of our journey.

Values:

Honesty and Transparency: We pride ourselves on being the most honest and transparent manufacturer in the industry. Our commitment to integrity extends to every aspect of our business, ensuring trust and openness with our stakeholders.

Sustainability: As stewards of the environment, we actively pursue sustainable practices. Our B Corp certification reflects our dedication to balancing purpose and profit, minimizing our ecological footprint, and contributing to a more sustainable future.

Innovation: Grounded in a legacy of innovation, we continuously push the boundaries of design to create ergonomic solutions that anticipate and meet the evolving demands of the modern workplace.

Employee Well-being: We prioritize the well-being of the individuals who engage with our products. By focusing on ergonomic principles, we contribute to the health and comfort of employees, fostering a positive and productive work experience.

Community Engagement: With a rich family legacy spanning four decades, we are committed to making a positive impact on the communities we serve that goes beyond doing business. Through active engagement and social responsibility, we strive to contribute to the betterment of society.

Pay off: Feeling at Work

This phrase captures our core ethos, emphasizing the importance of emotional and physical well-being in the workplace. At Dataflex, we believe that when individuals feel comfortable and supported in their work environment, they are empowered to thrive and contribute to a more harmonious and productive professional space.



Dataflex is a carbon neutral company



Dataflex is an ISO 9001 and 14001 certified company

A collection for every customer

We have seven collections. Our core collections, tailored to different budgets, each offering a comprehensive range of monitor arms, toolbars, and computer holders.

From the refined and elegant Viewprime, to the versatile, designer Viewlite, the no-nonsense, durable Viewmate, and the playful, value-for-money Viewgo. The Bento collection consists of designer products developed specifically, but not exclusively, for Activity-Based workplaces.

The Addit collection, a range of complementary accessories to complete your perfect workplace. And finally, Power, an unprecedented collection of electrification products from OE Electrics.

Our offer

People in every kind of business setting swear by our solutions. We've carefully arranged our wide offering in such a way that you can quickly find the solution that's just right for you.

Check out our website www.dataflex-int.com for all tools and possibilities.

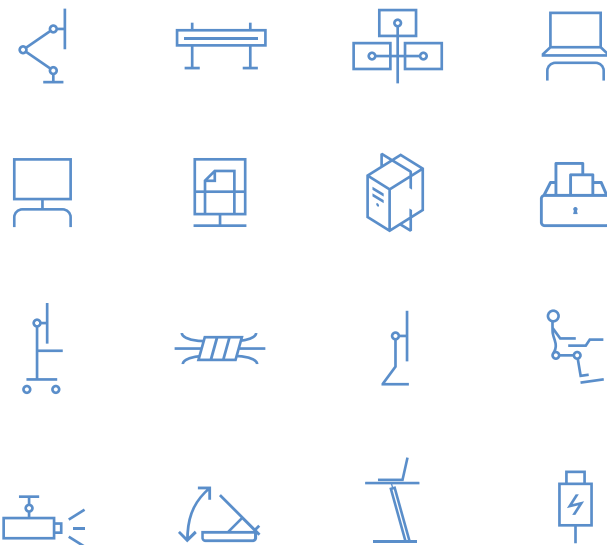

viewgo^x

Playful looks,
serious value



Different
Smart
Simple



viewprime^x

Superior usability through engineering finesse



Refined adjustability
Unparalleled agility
Elegant design



viewlite^x

Designed for tomorrow's change



World class design
Futureproof
Sustainable



viewmate^x

No-nonsense in every setting



Hassle-free
Cost effective
Durable



bento^x

Designed for the way we work today



Flexible
Healthy posture
Beautiful design



addit^x

So good you forget it's there



Finest materials
Refined stability
Complete reliability



power^x

Charged through the day



Highest possible quality
Timeless design
Futureproof

viewprime^x

Superior usability through engineering finesse



Refined adjustability
Unparalleled agility
Elegant design

Viewprime answers the call from organizations and users for more freedom of movement and adjustment options, while saving as much space as possible. High-quality workmanship and thoughtful design for connoisseurs, superior usability and simplicity for everyone. Viewprime ticks all your boxes.



reddot winner 2020

dataflex







Monitor arms

Great looks aren't worth anything if the quality isn't of the highest standard.

A Viewprime monitor arm moves smoothly and precisely, while being stable and sturdy when untouched. A high-end gas spring and precision engineered joints make the Viewprime not only a pleasure to look at, but a joy to use as well.



The benefits of Viewprime

- Suitable for every office environment
 - Precise fingertip height adjustment
 - Built-in gas spring
 - Refined design looks great in any setting
 - Great range of weight capacity
 - Height adjustment range makes Viewprime perfect for use with touchscreens
 - Monitor sliders make the arm perfect for use with partition walls and a great range of screen sizes (dual version only)
-

viewlite^x

Designed for tomorrow's change



World class design
Futureproof
Sustainable

Viewlite's many top design honours include a Red Dot and IF award. This collection fits subtly into any office design and continues to meet your needs, even when your workspace or requirements change. You can adapt products to accommodate anything from smaller technology to changing work practices. Also designed to minimise environmental impact, Viewlite is your answer to a world that never stands still.



reddot design award
honourable mention 2012



.IGR Institut für Gesundheit und Ergonomie



product design award

2013 ■

dataflex

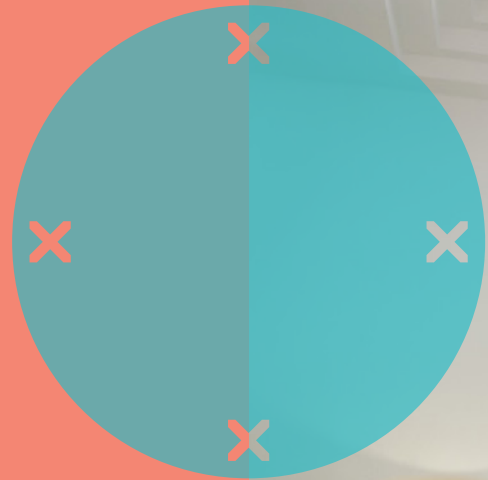





Monitor arms

With its wide variety of interchangeable parts, the lightweight modular system gives every organisation the flexibility to tailor the ideal solution for their needs, which contributes to a healthier, happier, more productive workplace. You can also go on reconfiguring the system to meet the changing IT or layout needs of your office and evolving requirements of your business. These monitor arms are 100% recyclable and 40% of the aluminium we use has already been recycled when we get it. So you're doing your bit for the environment, too.







Toolbars

These space-saving toolbars not only elegantly delineate between workplaces and support clean-desk policies, they also let you personalise and organise your workspace, and keep it clutter-free.



Computer holders

Suspended under your desktop from a choice of low or high mounting brackets, the holder is easy to mount vertically or horizontally under nearly any desktop surface, whatever your support beam system. Adjustable sliding parts mean it neatly encases a computer of any size. 100% recyclable and designed for disassembly.

The Viewlite Plus monitor arm is designed to be flexible and futureproof. It supports practically any monitor, and you can add additional optional mounts for a dual arm or a tablet. Desk sharing is also no problem, as the Viewlite monitor arm it can be continually adjusted and repositioned to accommodate people of any shape or size, whatever their ergonomic requirements.

The multiple award-winning design (including Red Dot and IF awards) combines superb ergonomics with strength, durability, attention-to-detail and a minimised environmental footprint.

Viewlite plus

Flexible, fashionable
and future-proof.



Integrated cable management

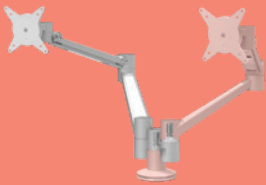

Expandable to dual screen version



Available in silver, white and black

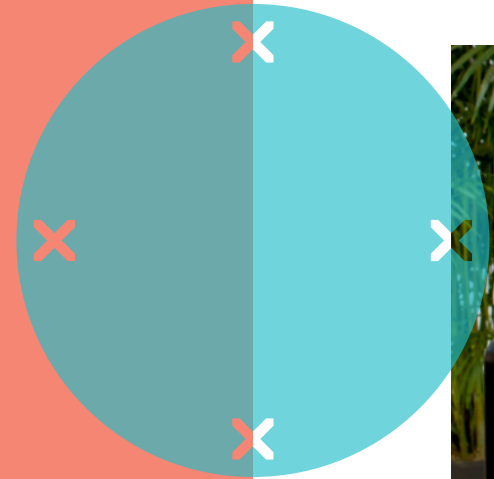
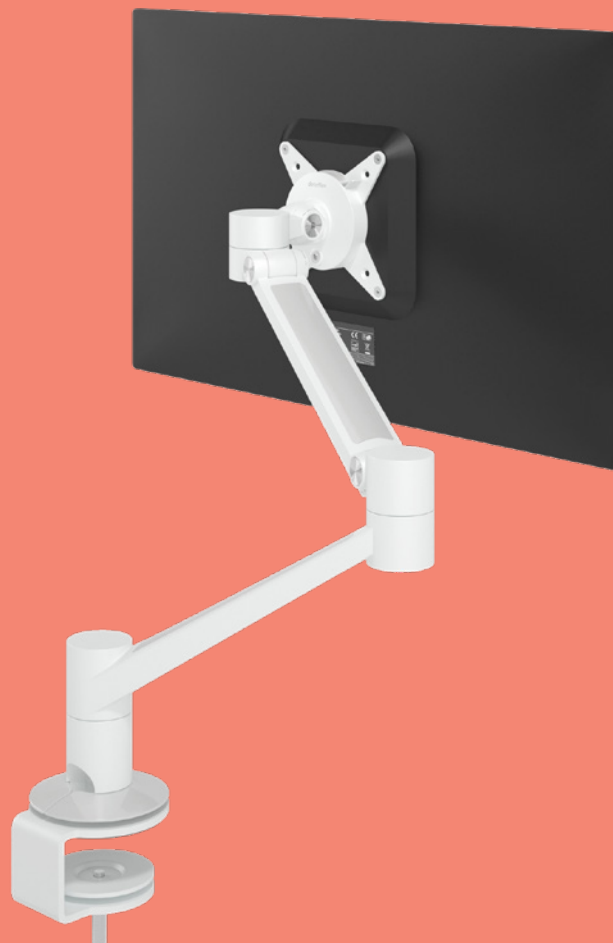



Benefits

- Increases productivity and employee wellbeing
- Great for flexible workspaces and sit-stand desks
- Helps to prevent workstation related health complaints
- Future-proof, scalable and upgradable
- Elegant design looks great in any office interior
- Easy to use and maintenance-free
- Suitable for even the lightest device!
- Hassle-free installation, saving time and money
- Compatible with the entire Viewlite collection

Features

- Made from 40% recycled aluminium
- Can also support a notebook or tablet
- Fitted with a practical quick-release VESA system
- Dynamic height adjustment range of 240 mm
- Weight capacity min. 0 kg - max. 7 kg per monitor
- Independent depth adjustment
- Integrated cable management
- Available in silver, white and black

viewmate^x

No-nonsense in every setting



Hassle-free
Cost effective
Durable

A no-nonsense, cost-effective collection equally happy in an office or industrial setting. From the wide, largely interchangeable product range to the heavy duty steel construction, if you're looking for a cost-effective hassle-free solution, Viewmate is for you. Most products are modular, configurable and upgradable; giving you the perfect combination of affordability and durability.

.IGR Institut
für Gesundheit
und Ergonomie







Monitor arms

Made from heavy-duty steel, and both upgradable and configurable, these monitor arms will last and last. Easy to install and adjust, they're also good news ergonomically. Most models are shipped with desk clamp, bolt-through desk, base plate, ceiling or wall mount.



Toolbars

A sturdy, cost-effective yet stylish solution for a tidy workspace that's also adjustable, so it meets your ergonomic requirements, too.

Providing a reliable, no-nonsense answer to even the roughest working environment.



Workstations

With their robust heavy-duty steel construction, Viewmate workstations can withstand the knocks they'll inevitably get during a long working life. They're also easy to install and adjust, and exceptionally good value-for-money. A modern solution for a modern office or industrial environment.



Computer holders

They have a high adjustment range, making them suitable for multiple form factors. All Viewmate computer holders are also theft-retardant, and the lockable security models completely anti-theft. This is a cost-effective solution that could save you more than just money.

viewgo^x

Playful looks, serious value



Different
Smart
Simple

—
This may be our entry-level collection, but that doesn't mean you have to compromise on quality. What's more, despite its original playful design you'll find Viewgo gets pretty serious when it comes to your comfort. It's easy to install, making smart use of materials to minimise costs and ergonomically designed with a tough construction. Where other entry-level products are cheap, the Viewgo collection is value-for-money.







Monitor arms

Freeing up valuable room on your desktop and letting you position your monitor the way you know you can work most effectively. Slender yet strong, these monitor arms all have that winning Viewgo formula: playful design, tough construction. High quality, value-for-money solutions that leave you sitting pretty in more ways than one.





Computer holders

Making it far less likely any harm will come to your precious computer from dust, spillages, accidental kicks, knocks when cleaning and so on. In other words, this cost-effective solution might well save you much more than just money.

bento^x

Designed for the way we work today



Flexible
Healthy posture
Beautiful design

A beautifully designed series of ergonomic accessories that help you organise things to fit the way you like to work. Each product offers its own specific benefits and is equally suited for digital devices or printed documents. The Dataflex Bento® range, available in black and white, is the perfect solution for activity based working, enabling productivity from anywhere.



red dot winner 2024
office design

dataflex

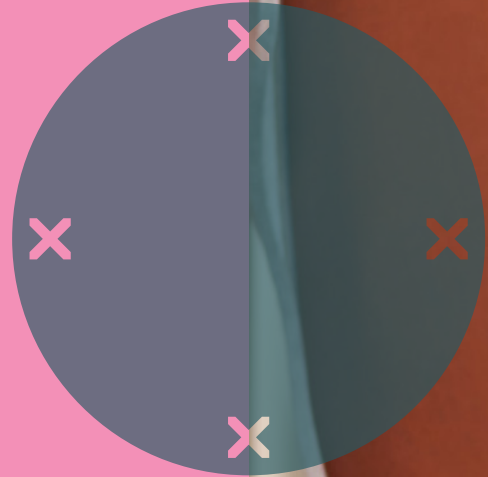





Monitor riser

The beauty of a design that is simple yet effective: this height adjustable Bento® monitor riser helps to improve your body posture by raising your monitor to eye-level. Its rubber feet ensure your monitor is perfectly stable and your desk remains scratch-free. The monitor risers also serve as a handy storage space for the Bento ergonomic toolbox.



Notebook stand

A notebook stand, tablet stand, in-line document holder and personal storage box in one! Ideal for shared-desk environments, activity-based areas and home offices. Organise, store and carry your personal items inside (helping to maintain a clean desk policy). Use your notes, documents and all of your favourite devices together ergonomically.



Desktop locker

The innovative Bento® desktop locker is the contemporary successor to the classic file cabinet, redesigned for Activity Based Work environments and modern work. Store your belongings in this beautifully designed personal locker that moves with your sit/stand workspace. Everything within reach, and when you're not at your desk, securely stored in the lockable soft-close drawer. The coat hook also keeps your backpack or (brief)case off the floor, and with the optional USB-A+C fast charger, your devices stay charged and ready for use.



reddot winner 2024
office design



Laptop table

The Bento® laptop table is designed for Activity Based Working environments but works and looks great almost everywhere. It has a safe, intuitive height adjustment mechanism and is suitable for soft seating and (task) chair environments. The combination of a flat, stable base and angled pole, offer best in class stability, easy mobility on both hard floors and carpets and gives you more legroom and reach. With its small stature and big personality, the Bento laptop table is a perfect addition to any workspace.



addit^x

So good you forget it's there



Finishing touch Blending in Complementary

You can combine Addit products with any of our other collections to make a good workplace work even better. They tidy away any clutter and let you tailor your workstation to your needs - so you can focus on your job. Simple yet effective solutions designed to complement our entire product portfolio and blend in perfectly with any working environment. Products so good you forget they're there.







Monitor risers

Addit monitor risers lift your monitor to the appropriate eye level. We've also pioneered the use of acrylic, which isn't only strong. Being transparent, it's also aesthetically appealing and appears to take up less desk space. The Addit collection offers you a wide range of risers, each with its own capabilities and applications. Because we realise that your combination of desk, chair, computer and monitor is unique.



Notebook risers

By raising your notebook to eye level, Addit notebook risers facilitate a far better working posture. You can sit more comfortably and don't have to bend forward awkwardly while reading or typing. Easing the tensions on neck, shoulders, arms and wrists. This makes working with your notebook more pleasant, and aids the prevention of RSI and CANS.



Document holders

Addit document holders aren't just convenient. They help you maintain a good posture, which can have major ergonomic benefits too. You can sit comfortably as you read or type without having to tilt your head or lean awkwardly. This eases the tensions on neck, shoulders, arms and wrists, which makes working with documents or notebooks more pleasant and reduces the chance of RSI or CANS.



Posture supports

Obviously a fast computer, good desk and comfortable chair are important. But to turn an OK workplace into your ideal working environment, you need to get the details right. Addit posture support accessories are particularly beneficial to you if you spend hours behind your desk. By helping relieve back, shoulder, wrist and other musculoskeletal complaints, so you're less fatigued and more productive all day.



AV solutions

Few modern offices can do without TVs or beamers. But they occupy a lot of space and are highly vulnerable to theft. Addit AV solutions will often support your equipment out of sight, and let you secure it with ceiling or wall mounts. This enhances the adjustability of your equipment and reduces the chances of theft.





Cable management

Loose cables. They're ugly, distracting and dangerous. Whether running beside your desk or hanging under it, they give a messy impression and are often just an accident waiting to happen.

But our cable management solutions don't just make your office look smart. Your workspace also becomes easier to clean and your IT systems easier to manage.



Discover our 100% recycled cable guides

- Tidies away below-desk cables
- Easy to adjust by adding/removing elements
- 100% recycled PP (Polypropylene)
- Made in the Netherlands: Dutch design, Dutch quality
- Eligible for Dataflex return program
- Fully customizable color and length



power^x

Charged through the day



Highest possible quality
Timeless design
Futureproof

—
Power, an unprecedented collection of electrification products from OE Electrics. We have worked with OE to select the best products that, when combined with our ergonomic workplace accessories, are a high-quality addition to any workplace. OE is the market leader in the UK and has a great edge when it comes to design, quality and durability. Every product is tested thoroughly and meets strict requirements.







In surface

You mount these electrification products in to the desk top. Space-saving, out of the way, but always accessible. Exceptionally compatible with our ergonomic workplace accessories.

Available with sockets for virtually all countries and equipped with the most powerful, future-proof USB-A+C ports. We have pre-selected the most common solutions for you. Also available in other configurations; contact us.



On surface

A varied range of high-quality electrification products for tabletop installation. Your power supply at your fingertips. Fully coordinated with our design language and therefore perfectly compatible with our ergonomic accessories.

Available with sockets for almost all EU countries and equipped with the most powerful, future-proof USB-A+C ports. We have pre-selected the most common solutions for you. Also available in other configurations; contact us.

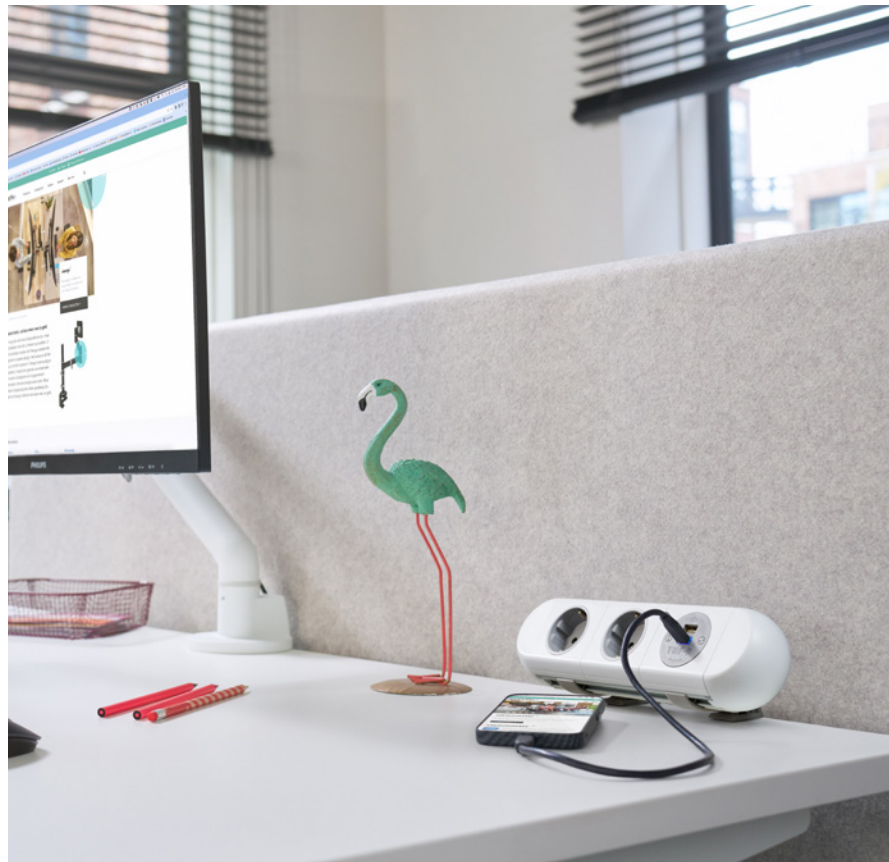

Your own **bespoke** configurations. As easy as **1,2,3,4.**

The configurator is an easy to use software tool on our website which lets you pick and choose out of many available parts within our Viewlite and Viewmate collection and helps you combine them into all kinds of unique configurations. With the configurator it's easy to make a monitor arm, toolbar or workstation that perfectly fits your needs.

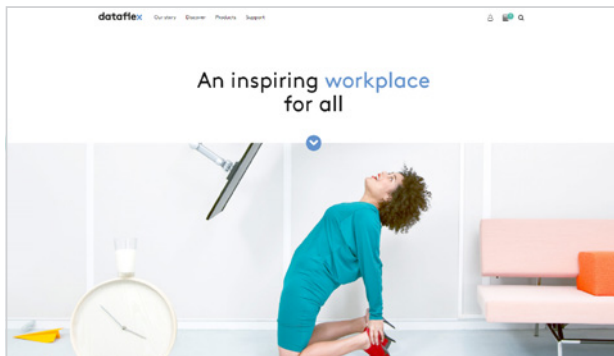

1. Go to www.dataflex-int.com.

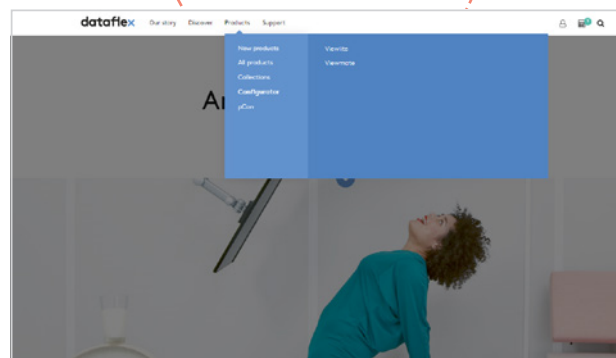

2. Use the top menu to go to the configurator.

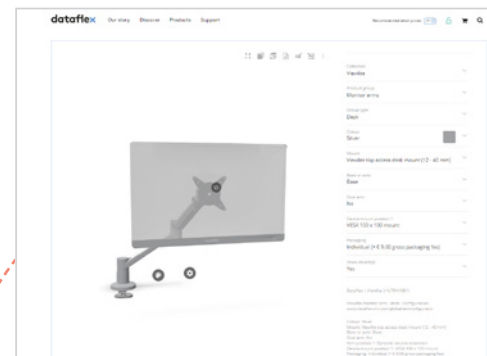

3. Mix, match and select the available options to make your perfect configuration.

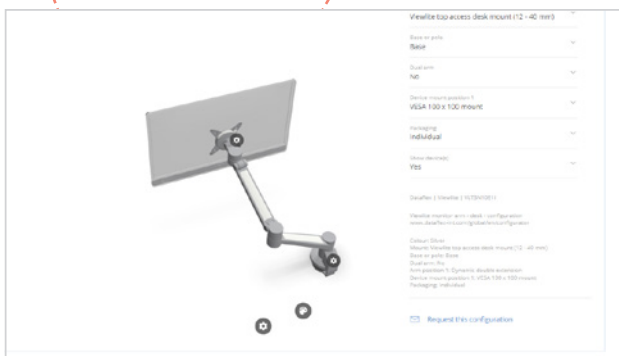
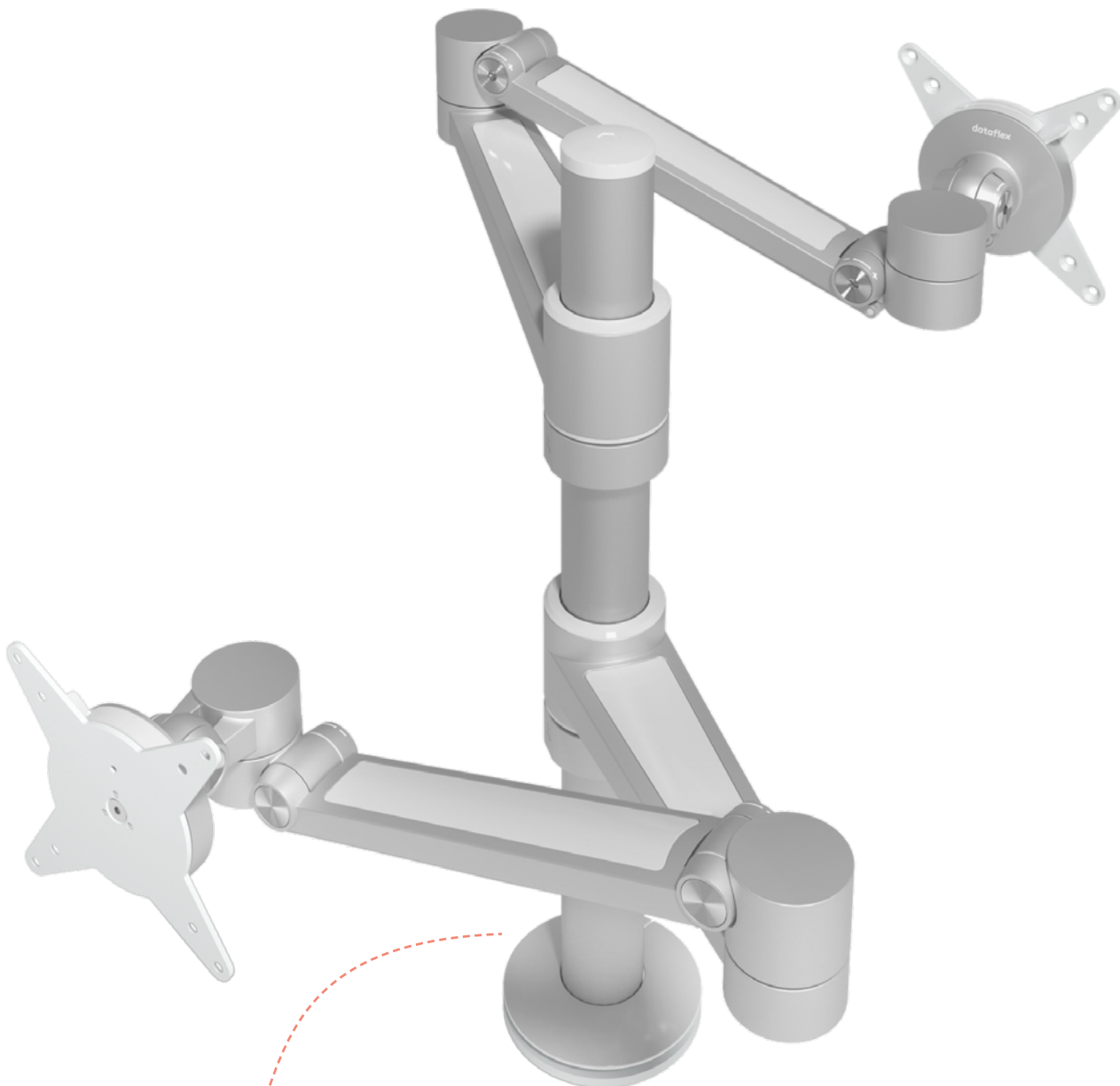

4. Request a quote for your masterpiece or order it online.

What about pCon / OFML?



All products available in our configurator are also available in OFML. Contact us for more information or visit our website.

Create your own bespoke solutions with our configurator at www.dataflex-int.com.

Taking ergonomics seriously

We design ergonomic products to enhance the physical and mental well-being of the people who use them.

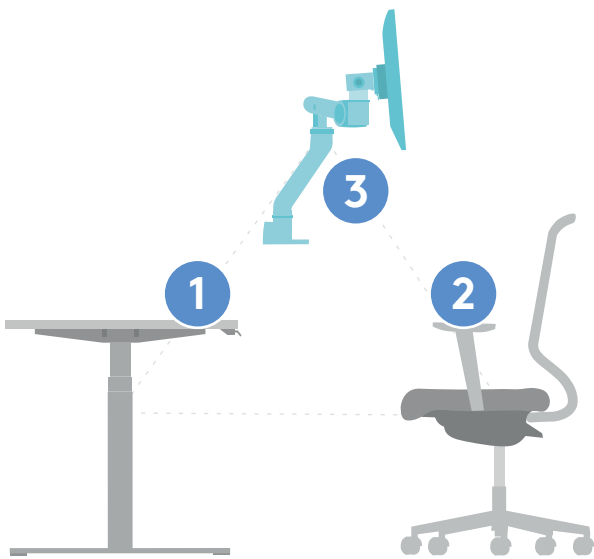

1, 2, 3

To achieve a truly efficient, comfortable and healthy workplace, we believe you have to look at ergonomics from a broader perspective. This is why Dataflex designs products that complement ergonomic chairs and desks to form a 'golden triangle' of office ergonomics.

Our driving principles

Underpinning this whole development process are some key Dataflex principles. Products should have a long lifetime, be easy and intuitively to use and modify, and simple to upgrade. No complicated gizmos or instructions.

It all comes back to our core philosophy: begin with people in mind and you won't go far wrong.

The perfect fit

When developing, we put ourselves in your shoes. How do you use our product, where will it fit into your workspace and day? We also consider the wider organisational perspective: is this product as upgradable, modifiable, sustainable and affordable as possible? And is the collection, as a whole, aesthetically versatile enough to fit different office designs and work cultures?

We are valued project partners

We are valued project partners, with extensive experience delivering customised requests and a long track record collaborating with architects, interior designers, furniture manufacturers and other specialists. We take pride in exceeding partners' expectations.

To learn more about our projects or discuss your own needs, please contact us: sales@dataflex-int.com



Doing things right, doing things responsibly

Because we want to do better tomorrow than we did today.

At our company, we are committed to providing progressive solutions that adapt to the changing needs of people in the modern workplace. Our commitment goes beyond innovation and quality; we strive to leave the smallest possible footprint on our planet. By incorporating sustainable practices into every aspect of our operations, from the well-being of our employees to the design of our products, we aim to have a positive impact on both the community and the environment. Ultimately, every step matters.

What it means in our day-to-day practice?
You will read about it here.





Certified B Corporation

Participating in a community that aims to be a force for good means we are constantly challenged to be better in terms of governance, employees, environment, community and customers.



A Social company, a Healthy Company

By prioritizing positive internal impact, we create a ripple effect that extends far beyond our walls.



Commitment to Climate Action

Since 2019, we have been offsetting our scope 1, 2 and 3 emissions. Our ultimate goal? To completely minimize the need for compensation.



Full transparency of our products

With life cycle analyses and material passports, we enable consumers to understand exactly what is in our products and their impact



Integration of circular economy

By extending the life cycle of a product, we can save up to 90% in emissions. Let's all contribute to a more circular world.



Guaranteed producer responsibility

With our commitment to sustainability, design for disassembly, right to repair and responsible packaging, we have it all under control.



We're carbon neutral!

We are international

www.dataflex-int.com

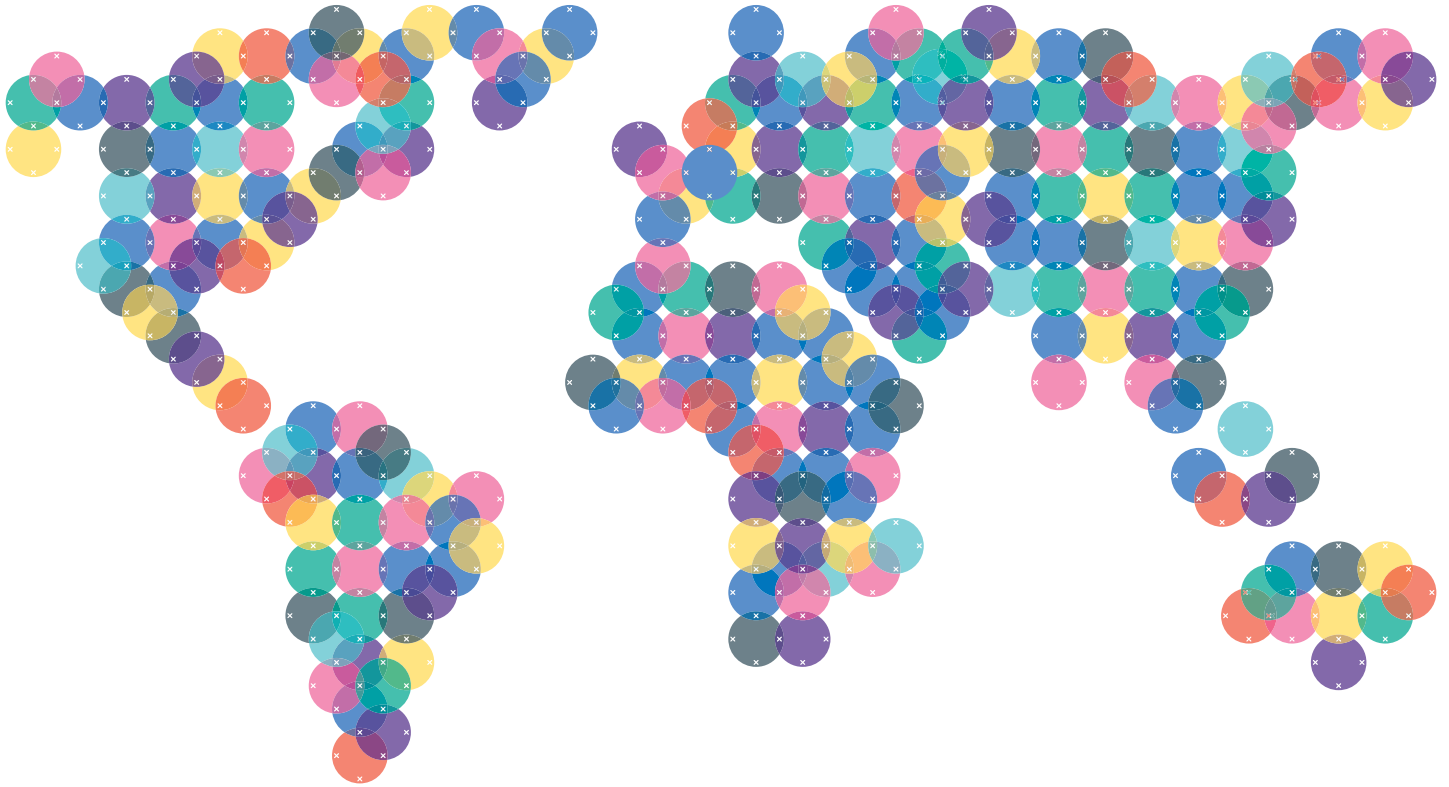

GEN-241110-BR-EN

Dataflex International BV
Global
T +31 180 515444
info@dataflex-int.com

Dataflex Deutschland GmbH
Germany & Austria
T +49 211 17607610
info@dataflex.de

Dataflex France Sarl
France
T +33 134 753738
info@dataflex.fr

Dataflex UK
United Kingdom & Ireland
T +44 20 3875 7734
info@dataflex-int.com

Dataflex Benelux BV
Benelux
T +31 180 530750
info@dataflex.nl

Dataflex Italia Srl
Italy
T +39 346 2233225
info@dataflexitalia.com

 [linkedin.com/company/dataflex---feeling-at-work](https://www.linkedin.com/company/dataflex---feeling-at-work)

 [instagram.com/dataflexfeelingatwork](https://www.instagram.com/dataflexfeelingatwork)

 [pinterest.com/dataflex_feelingatwork](https://www.pinterest.com/dataflex_feelingatwork)

dataflex

feeling at work